

ROUND TENONS

THE TV / TH SERIES BRACKETS ARE FOR USE WITH SQUARE & SQUARE TAPERED STEEL POLES. THE TV SERIES BRACKETS ARE DESIGNED FOR USE WITH THE 2AF ADJUSTABLE FITTER OR THE P4024D SLIPFITTER. THE TH SERIES IS DESIGNED FOR DIRECT FIXTURE MOUNTING. THE TENON PORTION OF THE MOUNTING BRACKET MEASURES 2 3/8" O.D. x 4" HIGH.

TH-SERIES

TH2180



TH290*

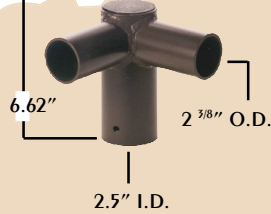

TH390*

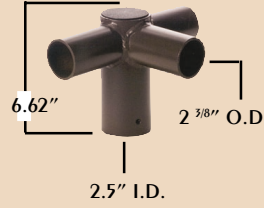

TH490*

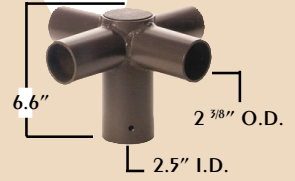

TH3120

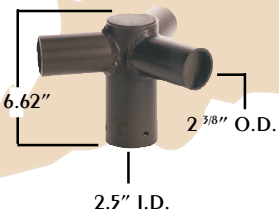

RTB SERIES

THE RTB SERIES TENONS ARE FOR USE WITH 6 - 12" WOODEN POLES. THIS LINE OF MOUNTING BRACKETS IS DESIGNED FOR USE WITH THE 2AF ADJUSTABLE FITTER. THE TENON PORTION OF THE MOUNTING BRACKET MEASURES 2-3/8" O.D.

RTB1



RTB3



RTB2



RTB4



Technical Data

THE TH SERIES TENONS ARE FOR USE WITH ALL POLE TYPES. THIS LINE OF BRACKETS ARE DESIGNED FOR USE WITH THE 2AF ADJUSTABLE FITTER ON SQUARE OR ROUND POLES.

Mounting Specifications

FOR 12", 16", & 22" HOUSING REQUIRING 2AF. FIXTURES MOUNTED TO THESE BRACKETS CAN BE ADJUSTED VERTICALLY. NOTE: THE TH290, TH490, & TH390 ARE FOR USE WITH 12" & 16" HOUSINGS ONLY.

OTHER HOUSING AND ARM CONFIGURATIONS ARE AVAILABLE. PLEASE CONTACT YOUR TECHLIGHT REPRESENTATIVE FOR MORE INFORMATION.

RV-SERIES

RV2

EPA .9

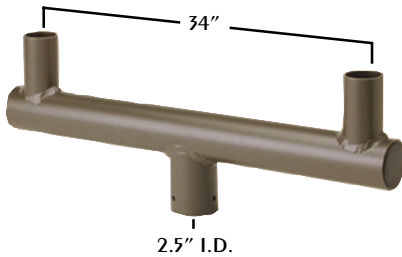

RV3

EPA 1.4

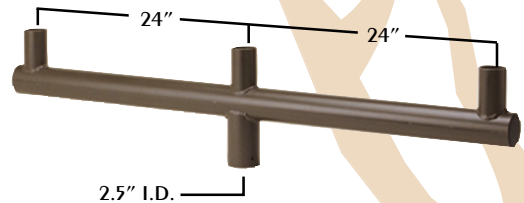

RV3120

EPA 2.2

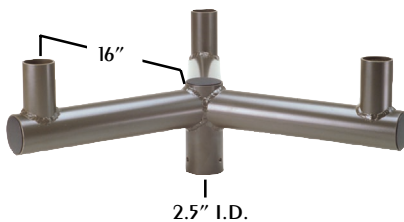

RVC4

EPA 2.2

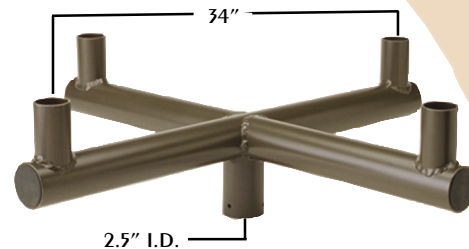

RV4

EPA 2.0

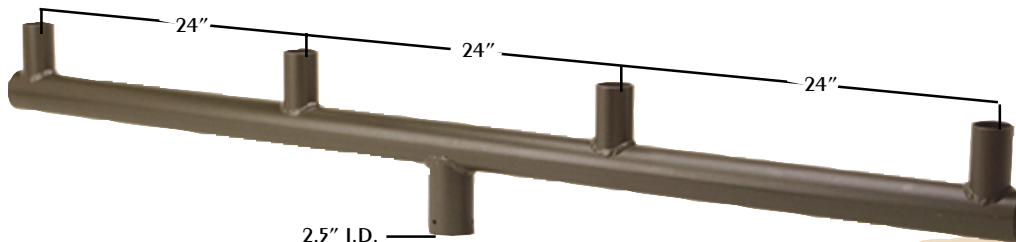

SQUARE TENONS

TV-SERIES

TVA4
4" BASE
TVA5
5" BASE
TVA6
6" BASE



TV2
EPA 1.6

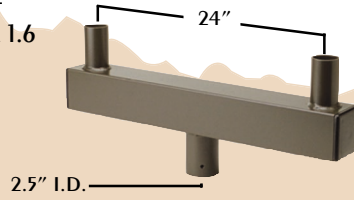

TV3
EPA 2.6

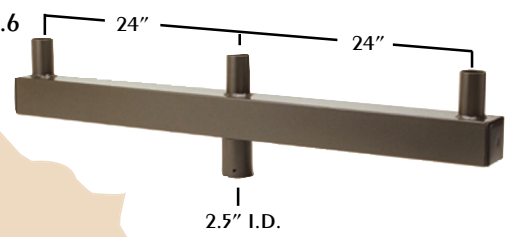

TH2
EPA 2.6

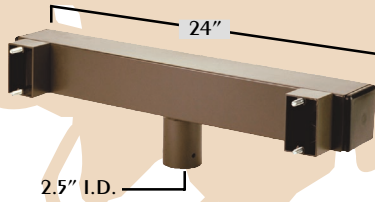

TH3
EPA 2.6

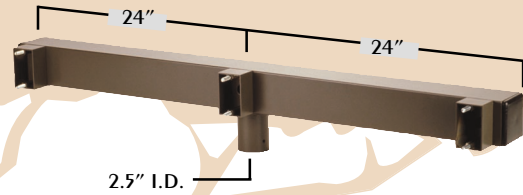

TV4
EPA 3.6

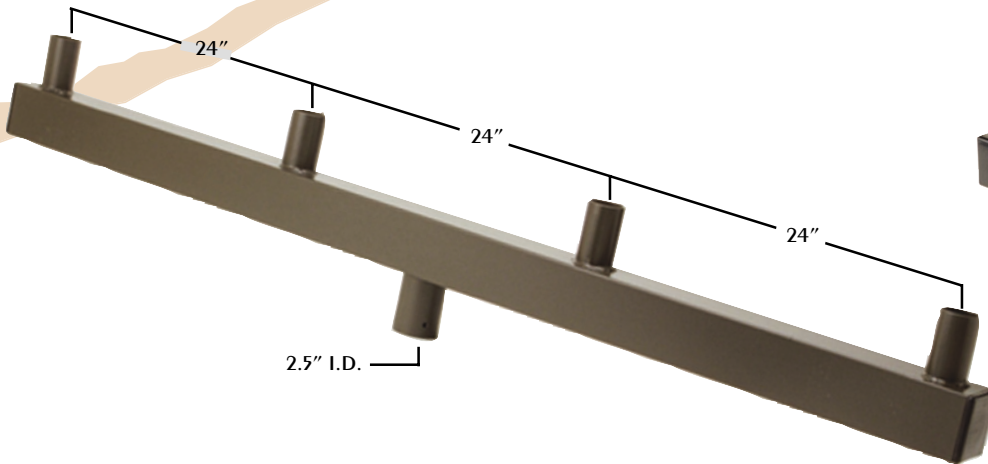

TVC4
EPA 2.2

